

- **Style: Simple**
- **Size: Mid Tower supports up to ATX MB**
- **Material: Steel & Tempered Glass**

Main Features

- **Connection** : Front I/O ports with 2 x USB 3.0 & 1 x USB 3.2 (Gen 2) Type C
- **Expansion** : 2+5 drive bays with modular drive trays design
- **Support** : Supports AIO cooling solutions



Specification

Model	V350 TG ARGB Air	V350 TG ARGB Air Snow
P/N	CA-1S3-00M1WN-03	CA-1S3-00M6WN-03
Case Type	Mid Tower	
Chassis Dimension (H*W*D)	475 x 220 x 461 mm (18.7 x 8.66 x 18.1 inch)	
Net Weight	8.46 kg / 18.65 lbs.	
Side Panel	Tempered Glass x 2	
Color	Black	White
Material	SPCC	
Cooling System	Front(intake): 120 x 120 x 25 mm ARGB fan (1000rpm, 27.2 dBA) x 3 Rear(exhaust): 120 x 120 x 25 mm Turbo fan (1200rpm, 22 dBA) x 1	
Drive Bays	2 x 3.5", 5 x 2.5" or 7 x 2.5"	
Expansion Slots	7 (Rotatable Patented Design)	
Motherboards	6.7" x 6.7" (Mini ITX), 9.6" x 9.6" (Micro ATX), 12" x 9.6" (ATX)	
I/O Port	USB 3.2 (Gen 2) Type-C x 1, USB 3.0 x 2, HD Audio x 1	
PSU	Standard PS2 PSU (optional)	
Fan Support	Front: 3 x 120mm, 2 x 120mm, 1 x 120mm 2 x 140mm, 1 x 140mm Top: 1 x 120mm, 1 x 140mm Right (M/B Side): 2 x 120mm, 1 x 120mm Rear: 1 x 120mm	
Radiator Support	Front: 1 x 360mm, 1 x 240mm, 1 x 120mm 1 x 280mm, 1 x 140mm Right (M/B Side): 1 x 240mm (vertical-installed GPU recommended), 1 x 120mm Rear: 1 x 120mm	
Clearance	CPU cooler height limitation: 160mm VGA length limitation: 360mm(With radiator) 390mm(Without radiator) PSU length limitation: 180mm (With HDD Cage) 220mm(Without HDD Cage)	

Packaging

Package Information	V350 TG ARGB Air	V350 TG ARGB Air Snow
EAN Code	4713227530798	4713227530804
UPC Code	841163080801	841163080818
N.W	8.46 kg / 18.65 lbs.	
G.W	9.89 kg / 21.8 lbs.	
Carton Size (L x W x H)	557 x 317 x 545 mm / 21.9 x 12.5 x 21.5 inch	
Cuft	3.4	
Container	w/o pallet	
20'	283 pcs	
40'	591 pcs	
40' HQ	671 pcs	





Thermaltake V350 TG ARGB Air Mid Tower Chassis

Appearance –
Black version



Angle view

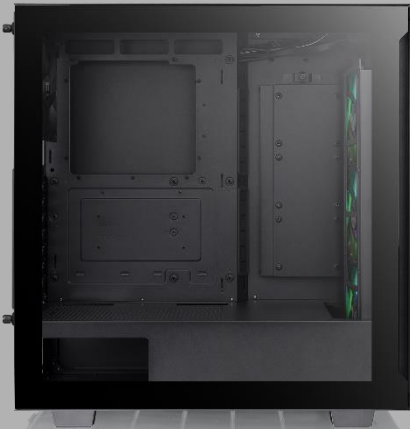

Left Side view



Front view



Right Side view



Internal Structure



Rear view



Top view



Bottom view



Thermaltake V350 TG ARGB Air Mid Tower Chassis

Appearance –
Snow version



Angle view



Left Side view



Front view

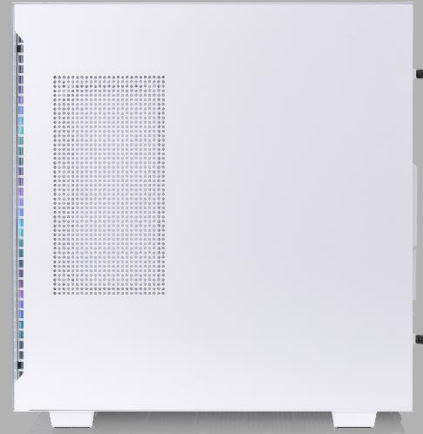

Right Side view



Internal Structure



Rear view



Top view



Bottom view



Thermaltake V350 TG ARGB Air Mid Tower Chassis

Clearance



Maximum support up to 120mm fan x 7

Maximum radiator support up to 360mm at front



3mm Tempered Glass Window x 1



Thermaltake V350 TG ARGB Air Mid Tower Chassis

Pre-installed
ARGB Fans



Pre-installed three hydraulic bearing 120mm ARGB front fans which can effectively lower the operation noise and enhance the thermal efficiency.



Divider 350 TG ARGB Air



Divider 350 TG ARGB Air Snow

SPEC for Case ARGB fans

-Fan Speed: 1000 +/- 10% RPM

-Fan Airflow: 45 CFM

-Fan Air Pressure: 0.82 mm-H₂O

-Fan Noise Level: 27.2 dBA

-Fan Bearing: Hydraulic bearing

ARGB lighting Control Instruction

I/O Port

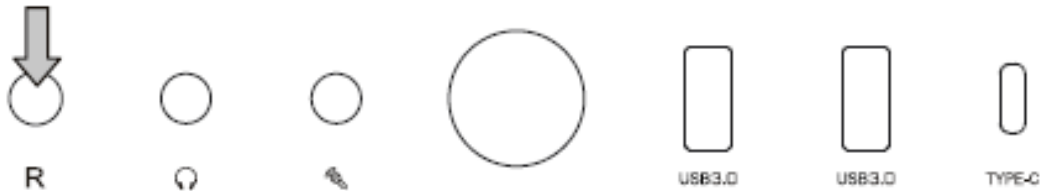

- Wave Mode** Mode 1
- Flow Mode** Mode 2
- RGB Lighting** Mode 3 (Single Color)
- Radar Mode** Mode 4~10
(Red, Yellow, Green, Cyan, Blue, White, Purple)
- Breath Mode** Mode 11~18
(RGB, Red, Yellow, Green, Cyan, Blue, White, Purple)
- Full Lighted Mode** Mode 19
- Single Color** Mode 20~26
(Red, Yellow, Green, Cyan, Blue, White, Purple)
- Light Off** Mode 27

⊗ Long press on RGB button for 3 seconds, fan will blink twice which now are controlled by MB software. And vice versa.

How to connect MB

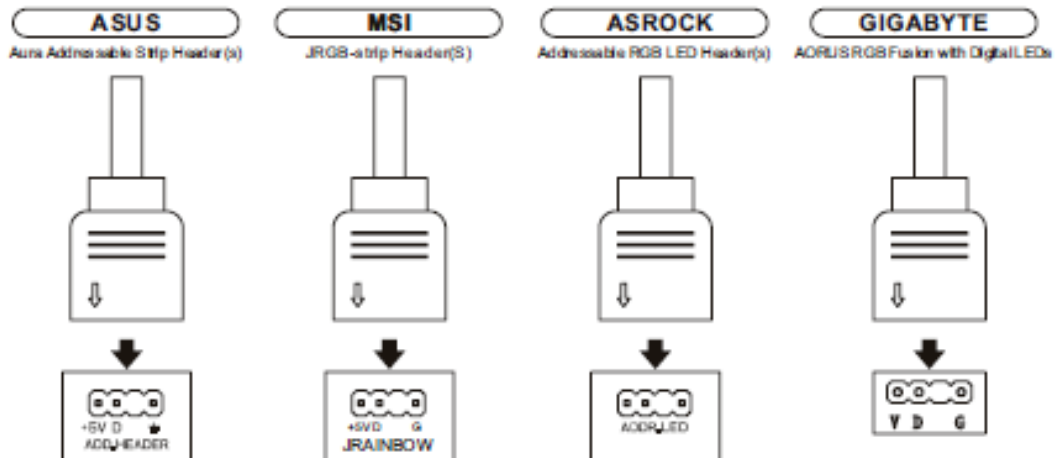



Thermaltake V350 TG ARGB Air Mid Tower Chassis

Structure (External)



USB 3.2 (Gen 2) Type-C x 1

USB 3.0 x 2

HD Audio

Tool-free,
easy-to-remove
Panels design

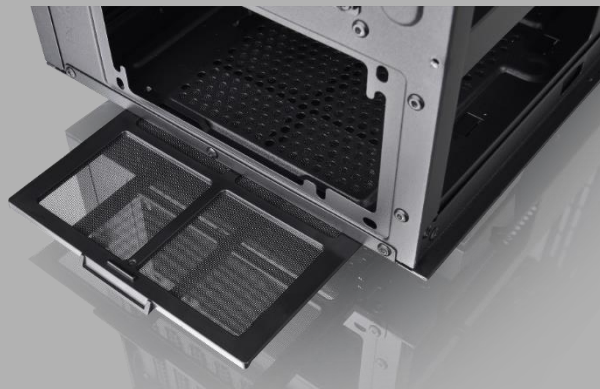
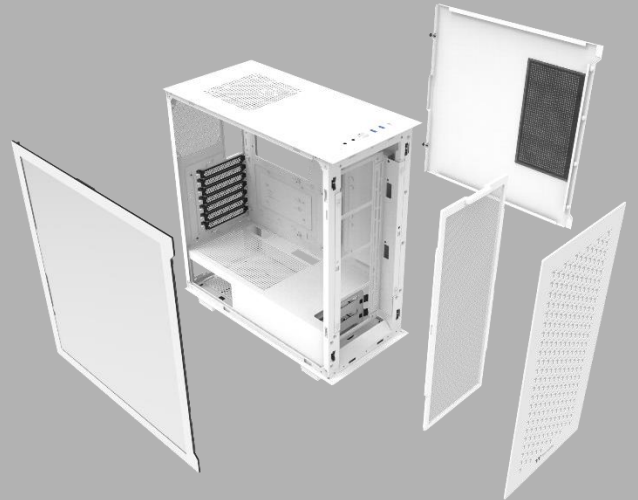

Bottom filter



Thermaltake V350 TG ARGB Air Mid Tower Chassis

Structure (Internal)

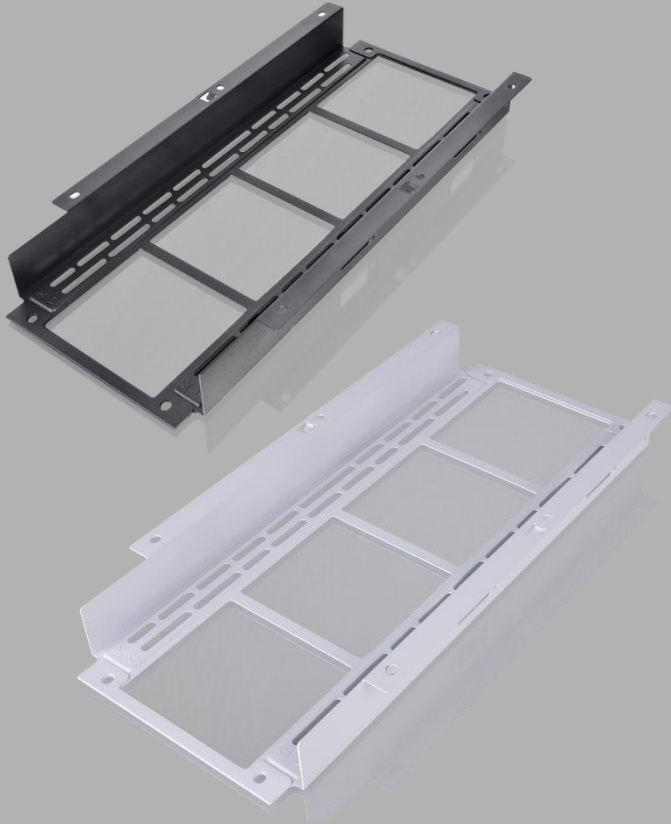

Removable front fan/radiator bracket for easier installation



Preinstalled 120mm rear fan

Structure (Internal)



Full length power cover



Cable cover design for cleaner internal look

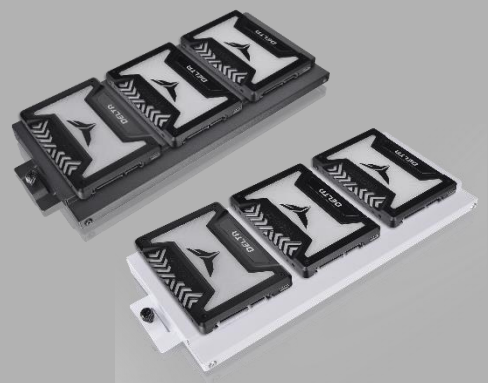
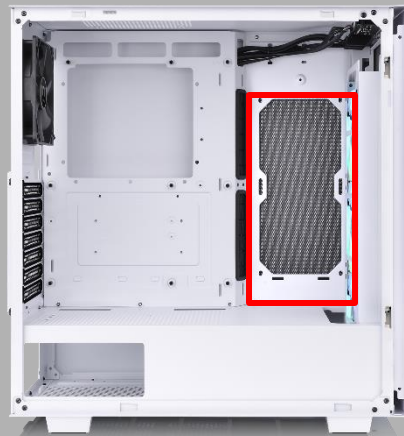
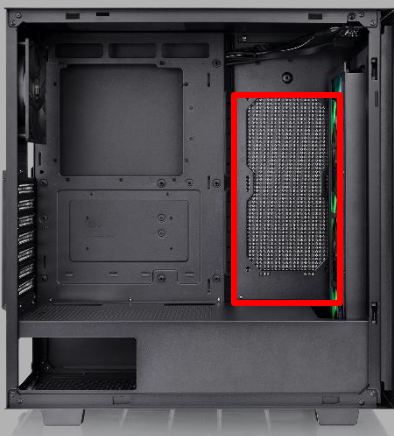

It can support up to 3 2.5" SSD

Structure (Internal)



Front filter



Top filter

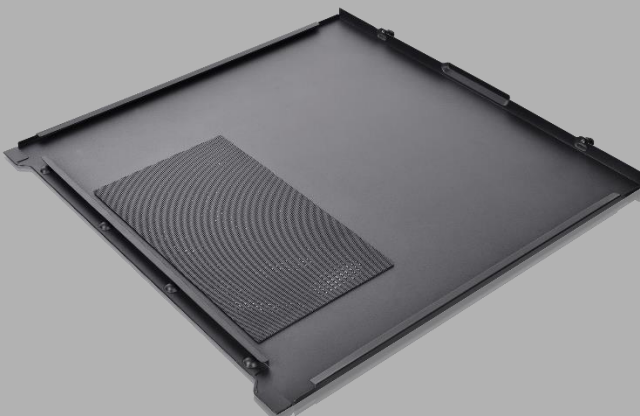

Right side filter

Rotational VGA bracket design



Horizontal VGA
installation



Vertical VGA
installation

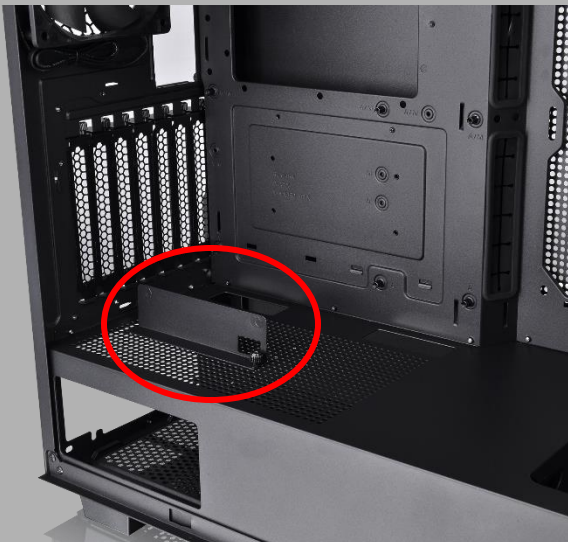

VGA Support Bracket in
accessory box supports
vertical VGA installation



Thermaltake V350 TG ARGB Air Mid Tower Chassis

Exploded View

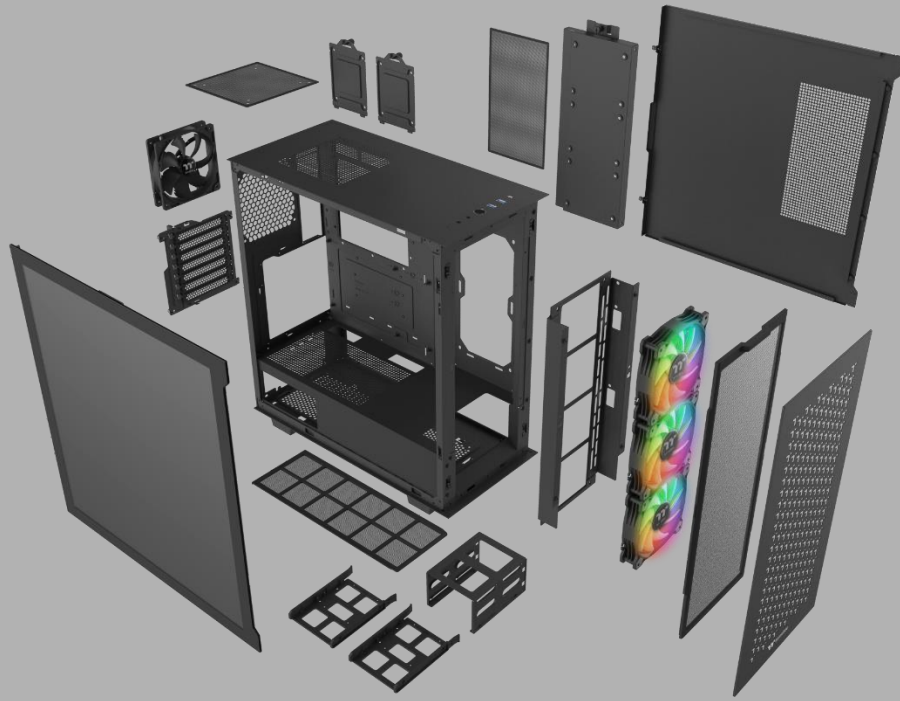

Compatibility List

Fan Compatibility List			
	120mm	140mm	200mm
Front	3	2	-
Top	1	1	-
Rear	1	-	-
Right	2	-	-

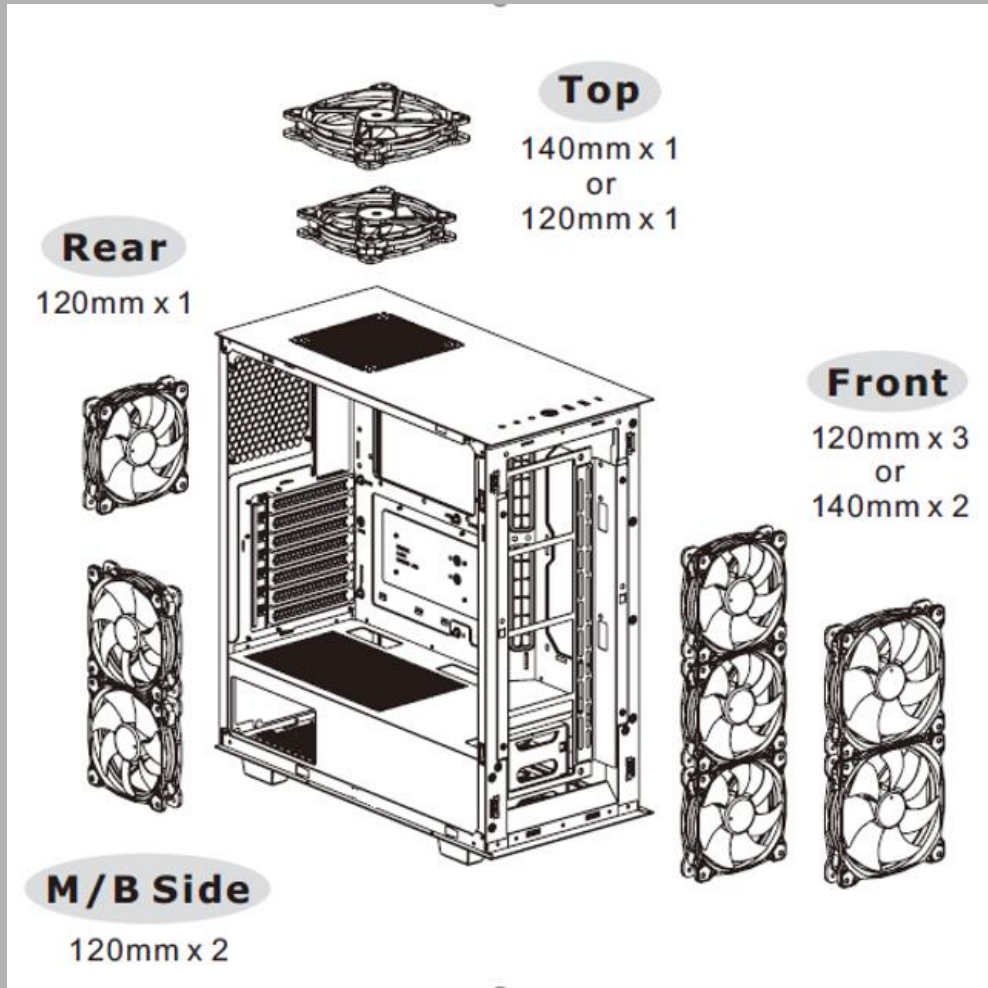

All-in-One Compatibility

All-in-One Compatibility List						
	120mm	240mm	360mm	140mm	280mm	420mm
Front	●	●	●	●	●	-
Right	●	●	-	-	-	-
Rear	●	-	-	-	-	-
Bottom	-	-	-	-	-	-

