

- **Style: Simple**
- **Size: Mini case supports up to Mini-ITX MB**
- **Material: Steel & Tempered Glass**

Main Features

- **Connection :** Front I/O ports with 2 x USB 3.0 & 1 x USB 3.2 (Gen 2) Type C
- **Cooling Solution :** Pre-installed 140mm CT140 Fan x 2
- **Support :** Supports 280 mm AIO cooling solutions



Specification

Model	The Tower 200 Turquoise	The Tower 200 Racing Green	The Tower 200 Matcha Green	The Tower 200 Bumblebee
P/N	CA-1X9-00SBWN-00	CA-1X9-00SCWN-00	CA-1X9-00SEWN-00	CA-1X9-00S4WN-00
Case Type	Mini Tower			
Chassis Dimension (H*W*D)	537 x 300 x 280 mm (21.14 x 11.8 x 11 inch)			
Net Weight	7.7 kg / 16.98 lbs.			
Panel	3mm Tempered Glass x 1			
Color	Turquoise	Racing Green		Matcha Green
Material	SPCC			
Cooling System	Top(exhaust): 140 x 140 x 25 mm CT140 fan (1500rpm, 30.5 dBA) x 1 Rear(exhaust): 140 x 140 x 25 mm CT140 fan (1500rpm, 30.5 dBA) x 1			
Drive Bays	2 x 3.5", 2 x 2.5" or 4 x 2.5"			
Expansion Slots	3			
Motherboards	6.7" x 6.7" (Mini ITX)			
I/O Port	USB 3.2 (Gen 2) Type-C x 1, USB 3.0 x 2, HD Audio x 1			
PSU	Standard PS2 PSU (optional)			
Fan Support	Top: 1 x 120mm 1 x 140mm Right Side: 2 x 120mm, 1 x 120mm 2 x 140mm, 1 x 140mm Rear: 2 x 120mm, 1 x 120mm 2 x 140mm, 1 x 140mm Power Cover: 1 x 120mm 1 x 140mm			
Radiator Support	Top: 1 x 120mm 1 x 140mm Right Side(AIO): 1 x 240mm, 1 x 120mm 1 x 280mm, 1 x 140mm			
Clearance	CPU cooler height limitation: 200mm VGA length limitation: 280mm(With power cover) 380mm(Without power cover) PSU length limitation: 220mm			

Packaging

Package Information	The Tower 200 Turquoise	The Tower 200 Racing Green	The Tower 200 Matcha Green	The Tower 200 Bumblebee
EAN Code	4713227539418	4713227539425	4713227539432	4711475641044
UPC Code	841163089422	841163089439	841163089446	841163091050
N.W	7.7 kg / 16.98 lbs.			
G.W	9.65 kg / 21.27 lbs.			
Carton Size (L x W x H)	375 x 363 x 628 mm / 14.76 x 14.29 x 24.72 inch			
Cuft	3.04			
Container	w/o pallet			
20'	323 pcs			
40'	686 pcs			
40' HQ	797 pcs			



Appearance – Turquoise



Angle view

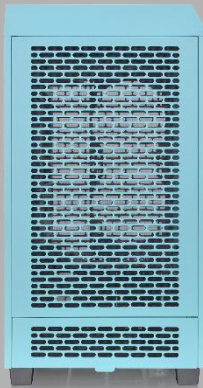

Left Side view



Front view

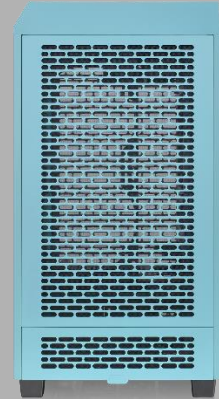

Right Side view



Internal Structure

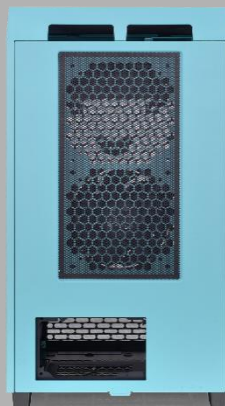

Rear view



Top view



Bottom view



Thermaltake The Tower 200 Mini Tower Case - Special Color

Appearance –
Racing Green



Angle view



Left Side view

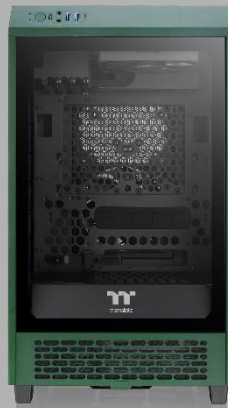

Front view



Right Side view



Internal Structure

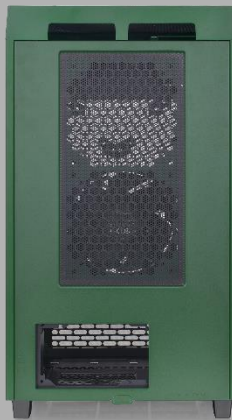

Rear view

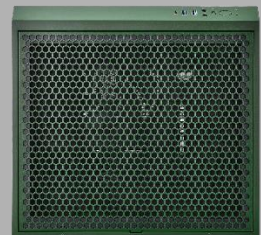

Top view

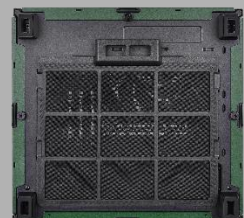

Bottom view



Thermaltake The Tower 200 Mini Tower Case - Special Color

Appearance –
Matcha Green



Angle view

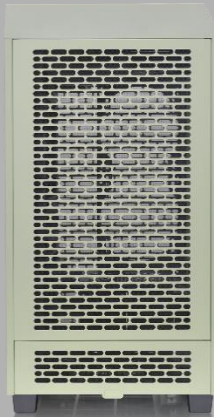

Left Side view



Front view

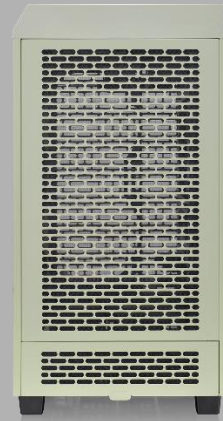

Right Side view



Internal Structure

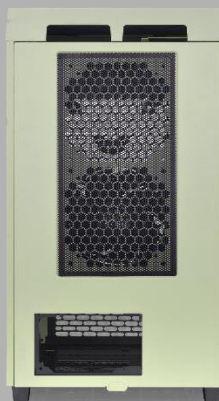

Rear view



Top view



Bottom view

Appearance – Bumblebee



Angle view

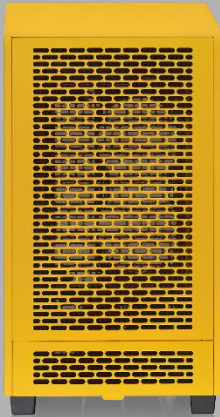

Left Side view



Front view

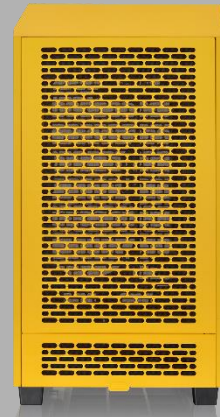

Right Side view



Internal Structure

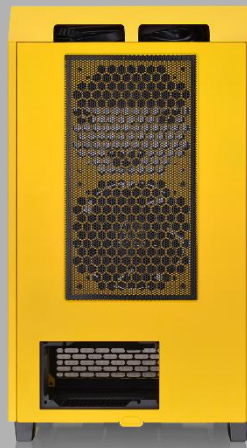

Rear view



Top view



Bottom view



Thermaltake The Tower 200 Mini Tower Case - Special Color

Unique Design



Unique Design



Supports ATX PSU



Maximum VGA length: 280mm



Thermaltake The Tower 200 Mini Tower Case - Special Color

Structure (External)



USB 3.2 (Gen 2) Type-C x 1

USB 3.0 x 2

HD Audio



Easy-to remove

Side panels with
dust filters



Structure (Internal)



One 140mm top fan



One 140mm rear fan

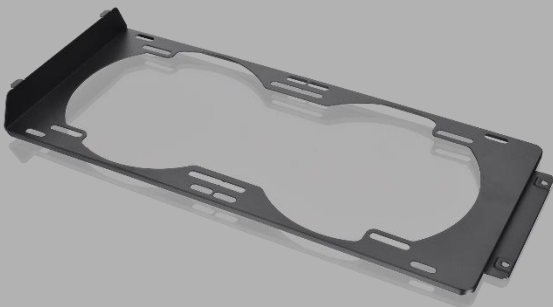

Right Side Bracket
for Radiator/Fan Installation

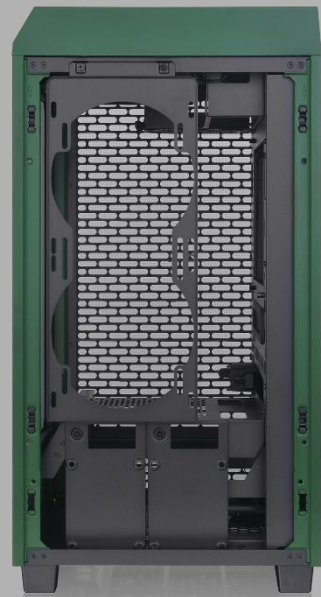

Structure (Internal)



2 x 2.5"



2 x 2.5" (with rear fan)



2 x 3.5" (without rear fan)

Pre-installed CT140 Fan



Pre-installed two hydraulic bearing 140mm **CT140** fans which can effectively lower the operation noise and enhance the thermal efficiency.

SPEC for Case ARGB **CT140** fans

- Fan Speed: 500~1500 RPM
- Max. Fan Airflow: 77.37 CFM
- Max. Fan Air Pressure: 2.3 mm-H₂O
- Fan Noise Level: 30.5 dBA
- Fan Bearing: Hydraulic bearing





Thermaltake The Tower 200 Mini Tower Case - Special Color

Exploded View

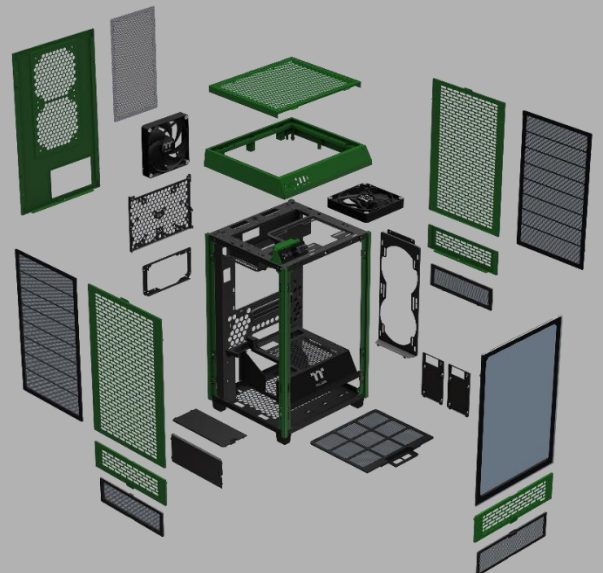
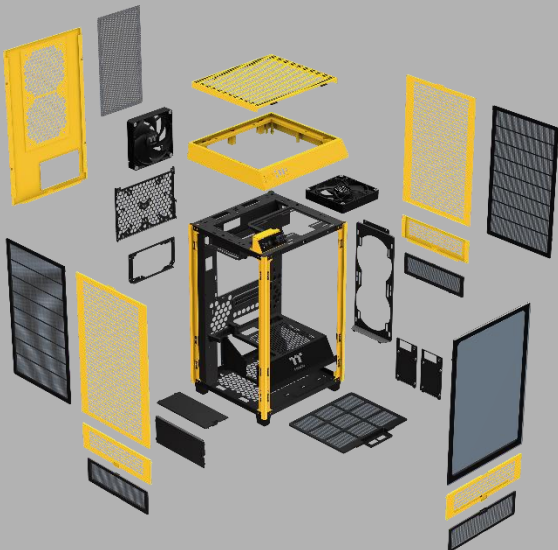
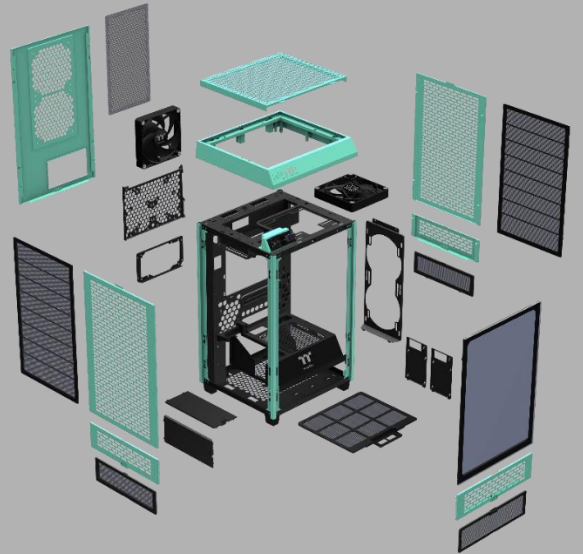
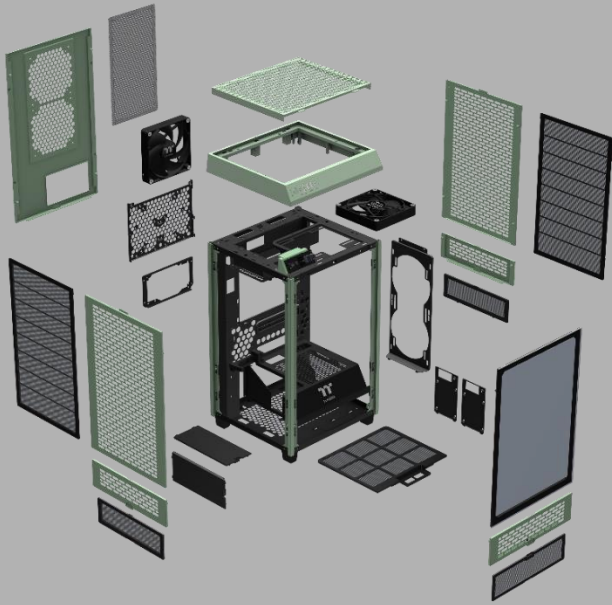

Compatibility List

Fan Compatibility List			
	120mm	140mm	200mm
Top	1	1	-
Right Side	2	2	-
Rear	2	2	-
PSU Cover	1	1	-

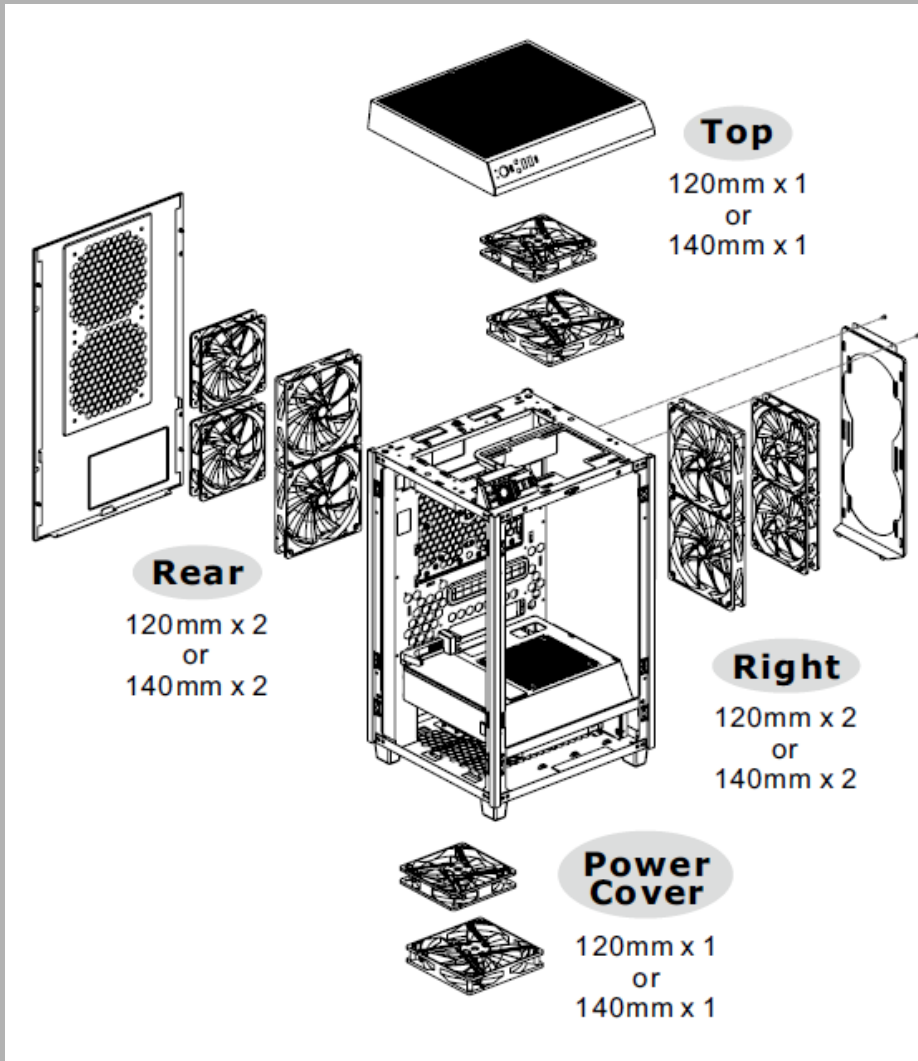

All-in-One Compatibility

All-in-One Compatibility List

	120mm	240mm	360mm	140mm	280mm	420mm
Top	●	-	-	●	-	-
Right Side	●	●	-	●	●	-
Rear	-	-	-	-	-	-

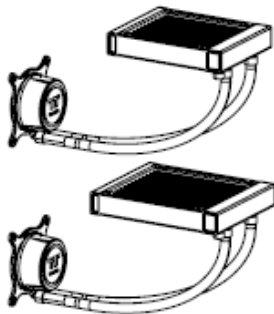

Top

120mm x 1
or
140mm x 1

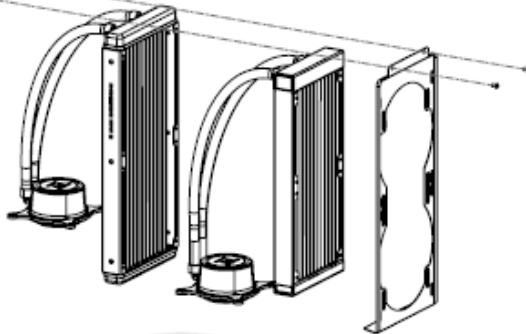
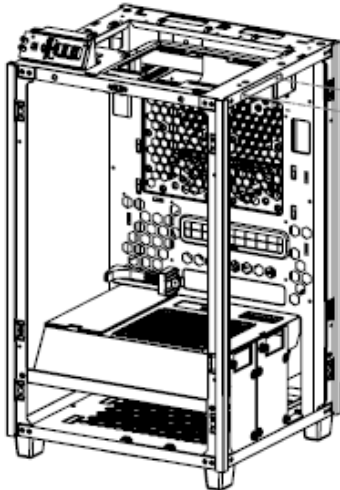

Right

240mm x 1
or
280mm x 1